

OXIMO[®]

SIMPLY WORKS



WINDSHIELD WIPERS FOR ALL CAR MODELS



www.oximo.pl

OUR VISION

OXIMO® – Wipers that keep up with your pace

At OXIMO®, we have always believed that a wiper is more than just a piece of rubber on a windshield. It is a small detail that makes a huge difference – for safety, driving comfort, and the quality of everyday experiences behind the wheel. That is why we created a brand that combines reliability, modern technology, and simplicity of choice.

We started with a clear goal: to offer a wide and transparent range of automotive wipers that meet the expectations of even the most demanding drivers. Today, our portfolio includes more than 400 models – and it continues to grow. Thanks to this, we are a recognized partner in the Polish market and an increasingly strong player across Europe.

Partnership that makes sense

We work with the leading automotive wholesalers in Poland, but our ambitions do not stop at the border. Step by step, we are expanding internationally, building lasting relationships based on trust, quality, and speed of action. Our partners value us for our intuitive B2B platform, fast logistics, and seamless communication. For us, this is the foundation of every successful partnership.

Certified quality and safety

OXIMO® wipers meet key international standards:

- EAC – compliance with technical and safety requirements in the Eurasian Customs Union.
- REACH – full compliance with EU regulations, ensuring chemical safety and environmental protection.

This gives our partners confidence that OXIMO® products are safe, durable, and reliable.

Technology that performs in every condition

OXIMO® is a brand that never stands still. We are continuously working to make our wipers better – more durable, quieter, and more efficient. We test, implement new solutions, and listen to users. Because technology is a tool – and our goal is the driver's comfort.



STRONG POINTS

WHY SHOULD YOU CHOOSE OXIMO?



Stock levels
minimum (pcs.)
2,1 mln +



Distribution
points
7,800 +



Individual
marketing
support



oximo.info
The most accurate
wipers online
search engine



Advanced
technology
manufacturing
PTFE



Matching cars by
TecDoc
83,400+



User-friendly
platform
B2B



OTIF
99,5%
On time in full
delivery rate



0.2%
Complaints
per year



51 mln+
Sold wipers

KEY FEATURES OF OUR PRODUCTS



Intuitive: Various colours and intuitive labelling on the packaging make it easy to choose the right OXIMO wiper series.

Simple installation: Easy and swift installation on the wiper arm, without the need for additional tools.

Precise fit: Modern design ensures even pressure and a perfect fit to the curve of the glass.

High quality materials: Wiper blades are made of high-quality synthetic rubber with a PTFE (Teflon) coating, and plastic components are made of durable Polyoxymethylene (POM), ensuring long product life.

Advanced design: Advanced blade profile and PTFE coating ensure effective water removal and quiet, smooth operation.

Corrosion resistance: High-carbon steel frame with an electrophoretic anti-corrosion treatment provides comprehensive rust protection.

Versatility: Suitable for all weather conditions, from freezing winters to hot summers.

Customer trust: The quality of our wipers is confirmed by years of proven performance and millions of satisfied drivers.

Eco-friendly: Manufactured in an environmentally responsible way, using recyclable materials where possible.

ONLINE SEARCH ENGINE



**HERE YOU CAN CHOOSE WIPER BLADES
FOR ANY CAR**

**CHECK
WWW.OXIMO.INFO**



An innovative tool for easily matching wiper blades to any car. The search engine was built based on our many years of experience.



ONLINE SEARCH ENGINE

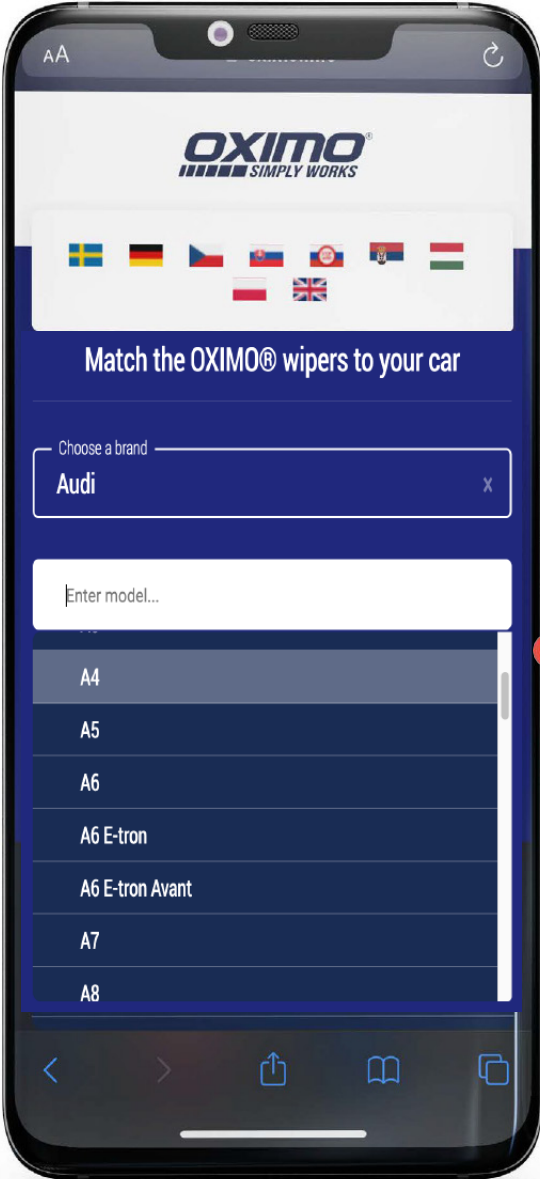

COMPARISON OF OXIMO MT SERIES VS BOSCH AP SERIES WIPER BLADES

OXIMO MT 350-800 mm



| | VEHICLE MARKET COVERAGE BY OXIMO MT | | VEHICLE MARKET COVERAGE BY BOSCH AP_U | |
|----|-------------------------------------|-------------|---------------------------------------|-------------|
| | MODELS | CARS | MODELS | CARS |
| PL | 2,502 | 26,141,808 | 797 | 16,490,133 |
| EU | 2,502 | 250,002,424 | 797 | 154,526,498 |
| | 99% | 98.7% | 31.40% | 61.81% |

Bosch AP_u 340-800mm



| ACCEPTED STATISTICAL DATA | | | |
|---|--|--|---|
| NUMBER OF PASSENGER CAR MODELS IN EUROPE WITH OXIMO MT SERIES MATCHES (ACCORDING TO THE OXIMO DATABASE) | | 2,540 | |
| NUMBER OF VEHICLES REGISTERED IN POLAND AS OF 31/12/2022 (ACCORDING TO CEPIK) | | 26,675,315 | |
| NUMBER OF VEHICLES REGISTERED IN EUROPE AS OF 31/12/2023 (ACCORDING TO ACEA) | | 253,295,262 | |
| NUMBER OF MATCHES BASED ON OXIMO MT SERIES PRODUCTS IN RELATION TO THE NUMBER OF VEHICLES REGISTERED IN POLAND (as of 31/12/2022) | | 26,141,808 | |
| OXIMO MT SERIES 350-800 MM WIPERS | NUMBER OF PASSENGER CAR MODELS FROM THE OXIMO DATABASE COMPATIBLE WITH OXIMO MT ADAPTERS | NUMBER OF ACTIVE ADVERTISEMENTS FROM MOBILE.DE BY OXIMO MT MOUNTING TYPE | NUMBER OF CARS REGISTERED IN POLAND THAT CAN BE EQUIPPED WITH OXIMO MT ADAPTERS |
| A | 88 | 27,697 | 521,813 |
| B | 155 | 134,224 | 2,528,796 |
| B1 | 9 | 427 | 8,051 |
| C | 234 | 270,667 | 5,099,401 |
| C1 | 227 | 383,823 | 7,231,275 |
| C3 | 14 | 19,449 | 366,429 |
| D | 84 | 38,979 | 734,367 |
| E | 30 | 7,268 | 136,930 |
| E1 | 10 | 5,706 | 107,511 |
| F | 13 | 3,591 | 67,646 |
| K | 12 | 10,162 | 191,447 |
| U | 1,626 | 485,567 | 9,148,142 |
| TOTAL | 2.502 | 1.387.562 | 26.141.809 |
| BOSCH WIPERS BASED ON AP_U 340-800 MM | NUMBER OF PASSENGER CAR MODELS FROM THE OXIMO DATABASE COMPATIBLE WITH BOSCH MOUNTS | NUMBER OF ACTIVE ADVERTISEMENTS FROM MOBILE.DE BY BOSCH MOUNTING TYPE | NUMBER OF CARS REGISTERED IN POLAND IN WHICH BOSCH MOUNTS CAN BE MOUNTED |
| A/A1/A2 | 88 | 27,697 | 521,813 |
| B | 155 | 134,224 | 2,528,796 |
| B1 | 9 | 427 | 8051 |
| C | 234 | 270,667 | 5,099,401 |
| C1 | 227 | 383,823 | 7,231,275 |
| N/A | N/A | N/A | N/A |
| D | 84 | 38,979 | 734,367 |
| | N/A | N/A | N/A |
| N/A | N/A | N/A | N/A |
| N/A | N/A | N/A | N/A |
| N/A | N/A | N/A | N/A |
| N/A | N/A | N/A | N/A |
| N/A | N/A | N/A | N/A |
| TOTAL | 797 | 693,470 | 16,123,704 |

IMPLEMENTATION OF OUR DATABASE IS EASY

Our products are in the TecDoc database along with crosses for Bosch and Valeo, and the implementation of our product database is easy and takes a minute.

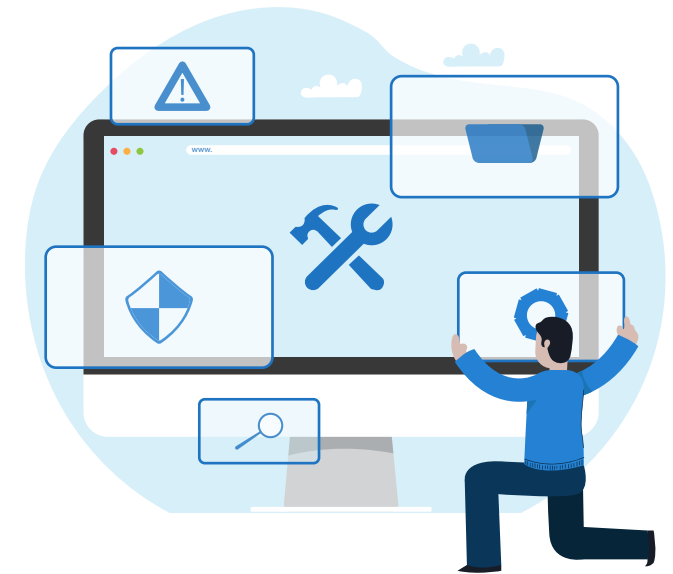

No access to TecDoc?



For clients without access to TecDoc (with their own e-shop or trading on e-commerce platforms) we provide complete data needed to issue an offer along with a complete set of current product photos.

QUALITY CONTROL



ELASTICITY TEST
QUALITY CONTROL



DURABILITY CONTROL
PRODUCT INSPECTION

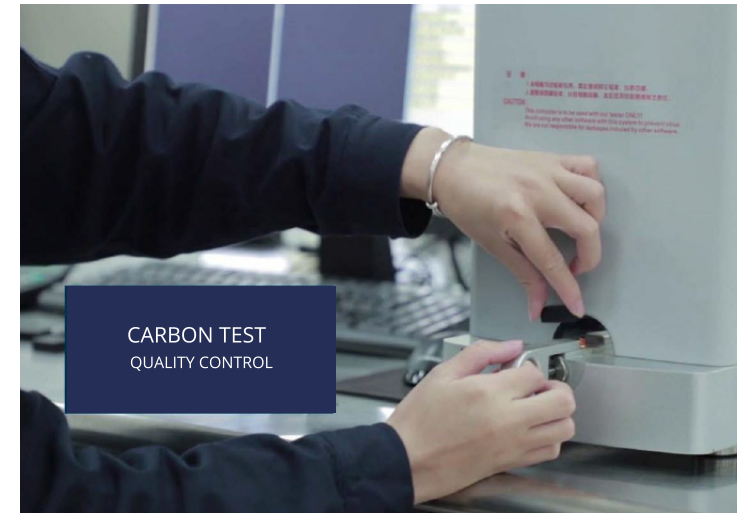

CARBON TEST
QUALITY CONTROL



VISUAL ANALYSIS
QUALITY CONTROL



Research and Development

We have a dedicated R&D centre at OXIMO®. We focus on improving our current products and discovering new solutions to the best of our abilities right there.

Material composition

High-quality steel, individual rubber blend, plastic elements based on polyethylene and polycarbonate. The steel rail inside the spoiler is made of high-carbon steel and is fully galvanized, which increases its durability.

Unique and innovative blend

We have introduced wipers that use PTFE (Teflon) as an additive to rubber. This compound is known for its low surface energy, which provides some lubricating properties and helps against contamination.

DURABLE CONSTRUCTION

METAL COMPONENTS ARE MADE OF HIGH-CARBON STEEL WITH AN ELECTROPHORETIC ANTI-CORROSION COATING

WIPER BLADE

IS MADE OF HIGH-QUALITY SYNTHETIC RUBBER WITH A PTFE (TEFLON) COATING

PLASTIC ELEMENTS

ARE MADE OF HIGH-QUALITY POLYOXYMETHYLENE (POM)

BUILT-IN SPOILER

INCREASES THE PRESSURE OF THE WIPER BLADE AGAINST THE WINDSCREEN WHILE DRIVING



PTFE (TEFLON) - THIS MATERIAL IS USED, AMONG OTHER THINGS, FOR ITS NON-STICK PROPERTIES, MINIMAL FRICTION COEFFICIENT AND UV RESISTANCE. THIS ENSURES EFFECTIVE WATER COLLECTION FROM THE WINDOW AND QUIET AND LONG-LASTING OPERATION.

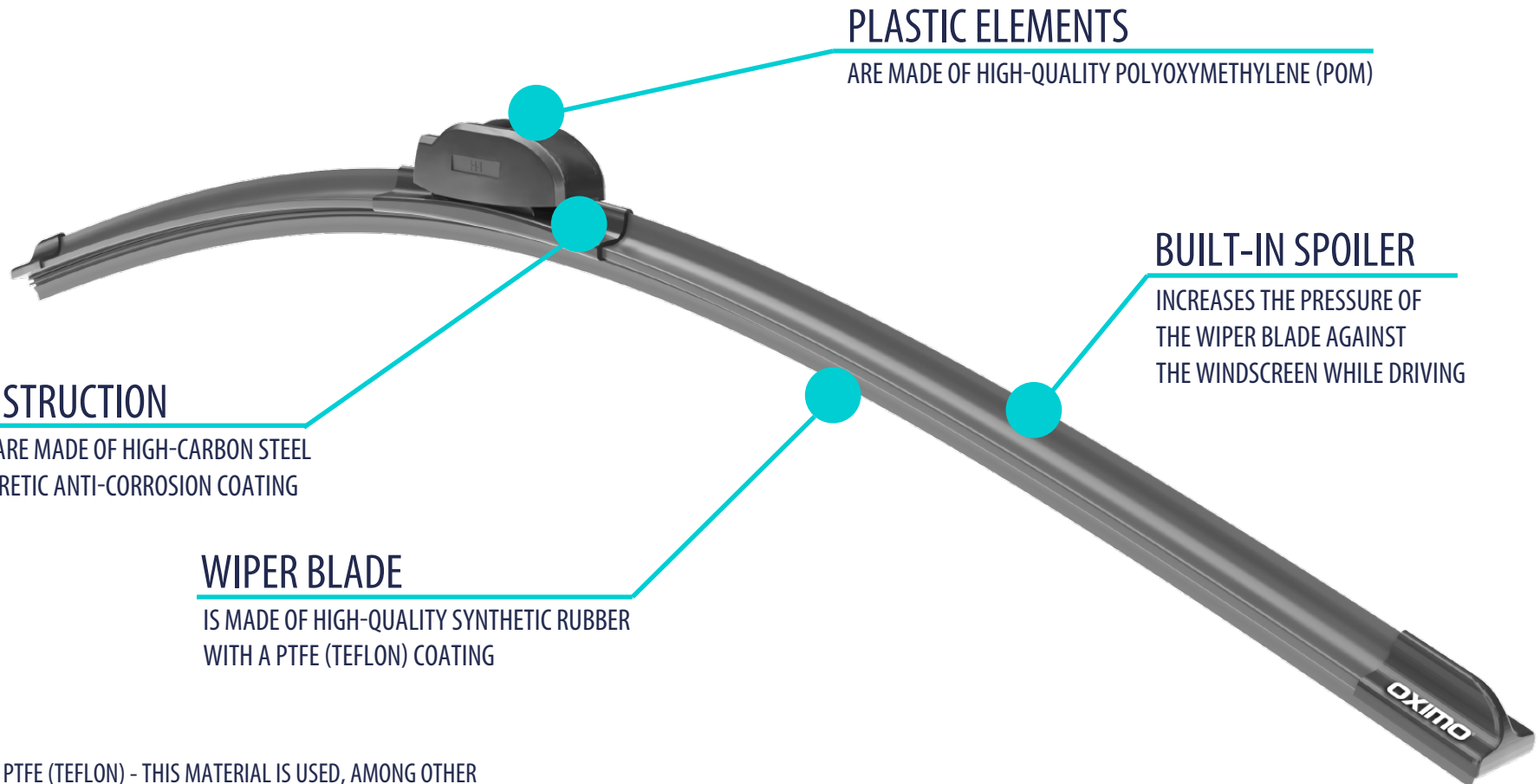

PERSONAL BRANDING

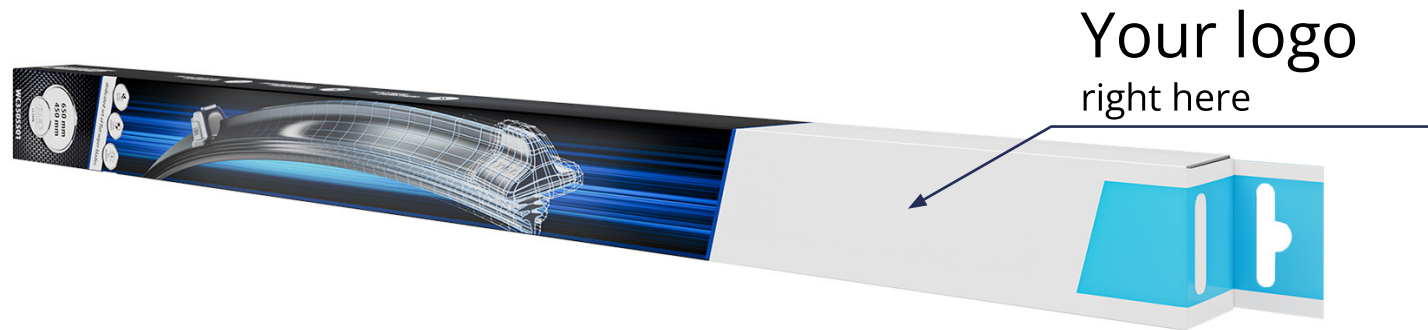

Unlock the potential of your own brands.

The OXIMO own brand program is designed for companies that want to develop the wiper market under their own brand. With over 14 years of industry experience and a presence in 30 countries, we offer a turnkey solution that covers everything from product development to logistics.

Why should you choose OXIMO®?

Know-how: Leverage our extensive experience in wiper manufacturing since 2009.

Quality assurance: Benefit from our commitment to high product quality supported by rigorous quality control measures.

Comprehensive packaging services We take care of the entire packaging process, from design to production.

Logistics support: Our comprehensive door-to-door service ensures a smooth transition from production stage to delivery.

Data-driven: Use our sales statistics and match tables covering over 68,000 car models to optimize your product offering.

MT multi-adapter wipers

Available lengths: 350 - 800 mm

Quantity in package: 1 pc

Construction: frameless

Frameless windscreen wipers with integrated spoiler. Multi-Type means that the wiper has interchangeable mounts of 12 types: U, A, B, B1, C, C1, C3, D, E, E1, F, K - matched according to catalogue. They have a built-in symmetrical double-sided spoiler, so they also fit cars with a right-hand steering wheel, as well as cars with a counter-rotating wiper system.



Available sizes of MT SERIES

| | | | | | | | | | | | | | | | |
|-------------|-------|-------|-------|-------|-------|------|-------|-------|-------|-------|-------|-------|-------|-------|-------|
| Inches | 14 | 15 | 16 | 17 | 18 | 19 | 20 | 21 | 22 | 23 | 24 | 26 | 28 | 30 | 32 |
| Millimeters | 350 | 375 | 400 | 425 | 450 | 475 | 500 | 525 | 550 | 575 | 600 | 650 | 700 | 750 | 800 |
| Symbol | MT350 | MT375 | MT400 | MT425 | MT450 | MT75 | MT500 | MT525 | MT550 | MT575 | MT600 | MT650 | MT700 | MT750 | MT800 |

WU, WU12 frameless wipers

Available lengths: 300 - 700 mm

Quantity in package: 1 pc

Construction: frameless

Type-U frameless wipers with lengths of 300 - 700 mm. U-type 9 mm and U-type 8 mm mounting in one. Wipers of this type are characterized by mountings on the so-called "hook" in the shape of the letter "U".



Available sizes of WU SERIES

| | | | | | | | | | | | | | | | |
|-------------|-------|-------|-------|-------|-------|-------|-------|-------|-------|-------|-------|-------|-------|-------|-------|
| Inches | 12 | 13 | 14 | 15 | 16 | 17 | 18 | 19 | 20 | 21 | 22 | 23 | 24 | 26 | 28 |
| Millimeters | 300 | 325 | 350 | 375 | 400 | 425 | 450 | 475 | 500 | 525 | 550 | 575 | 600 | 650 | 700 |
| Symbol | WU300 | WU325 | WU350 | WU375 | WU400 | WU425 | WU450 | WU475 | WU500 | WU525 | WU550 | WU575 | WU600 | WU650 | WU700 |

WUS frame wipers

Available lengths: 275 - 700 mm

Quantity in package: 1 pc

Construction: frame

Type-U wipers with a frame design. Fitted with 9 mm and 8 mm U-type adapters for mounting on: side pin (older US cars) and rail with screw (older Japanese cars).

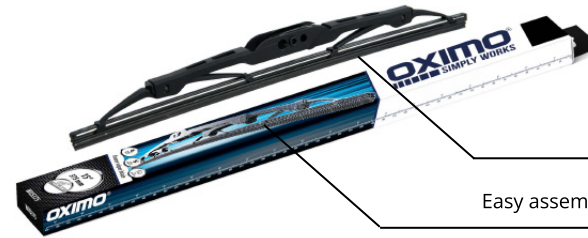

Classic tried-and-tested design

Easy assembly and high efficiency

Available sizes of WUS SERIES

| | | | | | | | | | | | | | | | | |
|-------------|--------|--------|--------|--------|--------|--------|--------|--------|--------|--------|--------|--------|--------|--------|--------|--------|
| Inches | 11 | 12 | 13 | 14 | 15 | 16 | 17 | 18 | 19 | 20 | 21 | 22 | 23 | 24 | 26 | 28 |
| Millimeters | 275 | 300 | 325 | 350 | 375 | 400 | 425 | 450 | 475 | 500 | 525 | 550 | 575 | 600 | 650 | 700 |
| Symbol | WUS275 | WUS300 | WUS325 | WUS350 | WUS375 | WUS400 | WUS425 | WUS450 | WUS475 | WUS500 | WUS525 | WUS550 | WUS575 | WUS600 | WUS650 | WUS700 |

WUSP, WUSPR frame wipers

Available lengths: 475 - 700 mm

Quantity in package: 1 pc

Construction: frame

Wipers of type U with frame construction and plastic spoiler. Available in lengths of 475 - 700 mm. They have U-9 mm and U-8 mm adapters, enabling mounting on the side pin (in older American cars) and on a rail with a screw (in older Japanese cars). WUSPR models have an additional integrated washer.

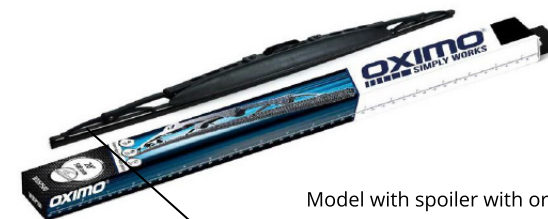

Model with spoiler with or without sprayer

Available sizes of WUSP SERIES

| | | | | | | | | |
|-------------|---------|---------|---------|---------|---------|---------|---------|---------|
| Inches | 19 | 20 | 21 | 22 | 23 | 24 | 26 | 28 |
| Millimeters | 475 | 500 | 525 | 550 | 575 | 600 | 650 | 700 |
| Symbol | WUSP475 | WUSP500 | WUSP525 | WUSP550 | WUSP575 | WUSP600 | WUSP650 | WUSP700 |

Available sizes of WUSPR SERIES

| | | | | |
|-------------|----------|----------|----------|----------|
| Inches | 22 | 23 | 24 | 26 |
| Millimeters | 550 | 575 | 600 | 650 |
| Symbol | WUSPR550 | WUSPR575 | WUSPR600 | WUSPR650 |

WUH hybrid wipers

Available lengths: 350 - 700 mm

Quantity in package: 1 pc

Construction: hybrid

Our innovative hybrid wiper line features a 9mm U-shaped mount and combines the advantages of frameless and steel designs.

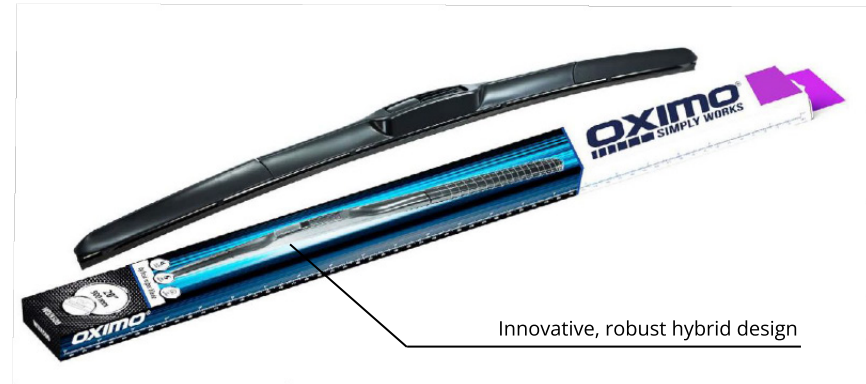

Available sizes of WUH SERIES

| Inches | 14 | 16 | 17 | 18 | 19 | 20 | 21 | 22 | 24 | 26 | 28 |
|-------------|--------|--------|--------|--------|--------|--------|--------|--------|--------|--------|--------|
| Millimeters | 350 | 400 | 425 | 450 | 475 | 500 | 525 | 550 | 600 | 650 | 700 |
| Symbol | WUH350 | WUH400 | WUH425 | WUH450 | WUH475 | WUH500 | WUH525 | WUH550 | WUH600 | WUH650 | WUH700 |

WA-WL dedicated wipers

Available lengths: 300 - 700 mm

Quantity in package: 2 pc (set)

Construction: frameless

The dedicated series offers a set of two frameless wipers. This series is a dedicated solution that comes with the specific elements for the vehicle model installed, making installation so simple. Each package contains a set of two wipers in the appropriately selected length, providing a complete solution for the windshield.



WUSAG wipers for trucks and buses

Available lengths: 650 - 1000 mm

Quantity in package: 1 pc

Construction: steel frame

Wipers with a traditional steel frame construction with 4 different types of mounting: U-type in 9 mm and 12 mm width and for screw fixing in 16.2 mm width, U-fixing 16 mm, screw fixing (width 13.6 - 16.5 mm) and screw fixing (width 21 mm and 25 mm). Dedicated to some models of buses and trucks.

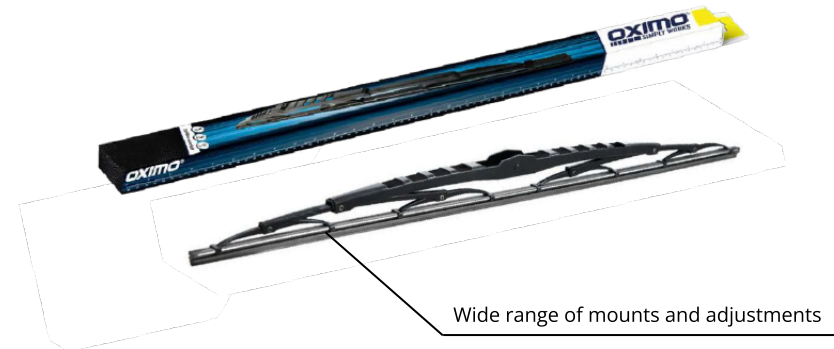

WR rear window wiper

Available lengths: 175 - 600 mm

Quantity in package: 1 pc

Construction: frame/frameless

Rear window wiper. It has dedicated mounts and appropriate lengths (mm) for a specific vehicle model.



WRA rear window wiper with arm

Available lengths: 175 - 600 mm

Quantity in package: 1 pc

Construction: frame/frameless

Rear window wiper with arm. Features a dedicated mount and suitable length (mm) for the specific vehicle model.



Car-specific wiper arm kits

Classic stainless steel wipers in vintage style

Available lengths: 250 - 550 mm

Quantity in package: 1 pc

Construction: frame wipers, metal parts made of stainless steel

OXIMO® Classic wipers combine beautiful, old-school design with modern performance, ensuring good visibility and a smooth drive. This makes them suitable for everyday use which is enjoyed by classic car enthusiasts who value both style and functionality.

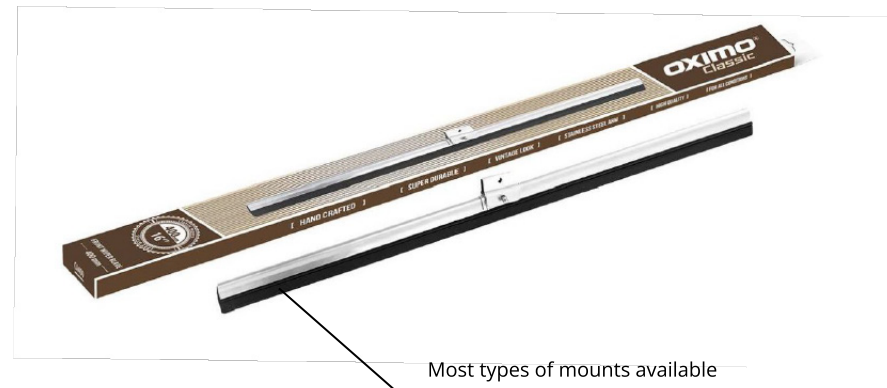

Most types of mounts available

WRMT rear window Multi-type flat wiper

Available lengths: 250 - 400 mm

Quantity in package: 1 pc

Construction: frameless

The WRMT series frameless wiper blade is a multi-adapter solution specifically engineered for rear window applications. It is compatible with a wide range of vehicle models, making it a highly versatile product for various automotive requirements. The kit includes specialized adapters to ensure compatibility with different mounting types – please refer to the application catalog for precise fitment.

Note: the number of adapters included in the set varies depending on the specific wiper blade length.

| Model | Length | Adapters in the set |
|----------|--------------|----------------------------|
| WRMT2501 | 250 mm / 10" | S3, S4, S5, S7, S8 |
| WRMT2801 | 280 mm / 11" | S2, S4, S5, S7, S8 |
| WRMT3001 | 300 mm / 12" | S1, S3, S4, S5, S7, S8, S9 |
| WRMT3301 | 330 mm / 13" | S2, S4, S5, S7, S8, S9 |
| WRMT3501 | 350 mm / 14" | S7, S8 |
| WRMT3801 | 380 mm / 15" | S2, S3, S4, S7, S8 |
| WRMT4001 | 400 mm / 16" | S2, S3, S4, S5, S7, S8 |



PACKAGING STANDARDS

- protective cover on the wiper blades
- unit packaging
- internal bulk packaging
- outer bulk packaging



x1

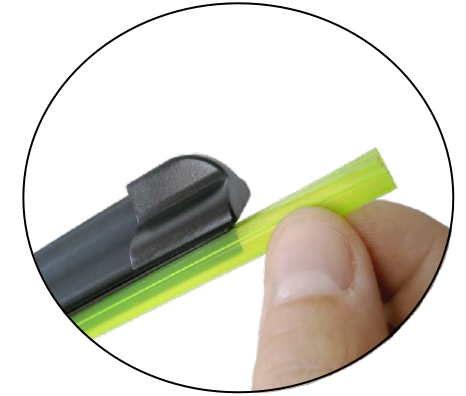

x10



5x10



DISPLAY SOLUTIONS



FLOOR STAND BIG

120 wipers max

Dimensions: 76 x 146 x 40 cm (width/height/depth)



FLOOR STAND SMALL

80 wipers max

Dimensions: 50 x 146 x 40 cm (width/height/depth)



WALL MOUNTED HANGER

36 wipers max

Dimensions: 49 x 21 x 16 cm (width/height/depth)

COOPERATION

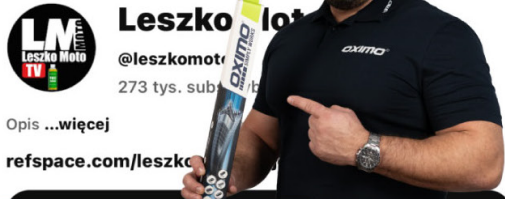

Grzegorz Leszko
@LeszkoMotoTV



Przemysław Szafrński
@motosynteza-szafranskiego



P-RALLY Team
@prally



DAKAR CLASSIC
4TH PLACE



Marcin Radecki
@RadioFLATOUT



Sebastian Kraszewski
@KicksterTV



OXIMO Racing Team
@oximo_racing_team

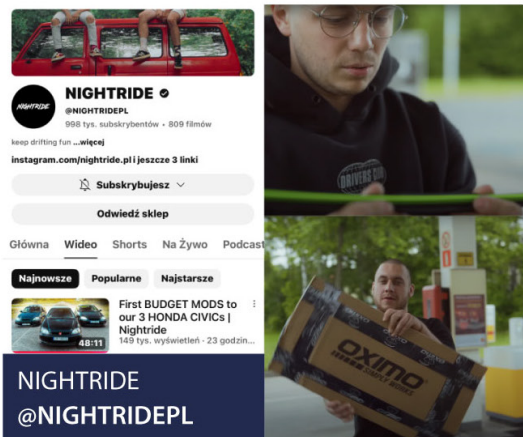

NIGHTRIDE
@NIGHTRIDEPL

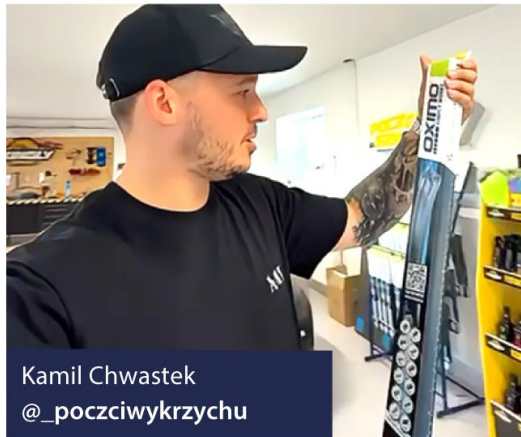

Kamil Chwastek
@_poczciwykrzychu



Piter Drift Team
@piter_drift_team

REACH ADVERTISING - YANOSIK APP & GOOGLE ADS

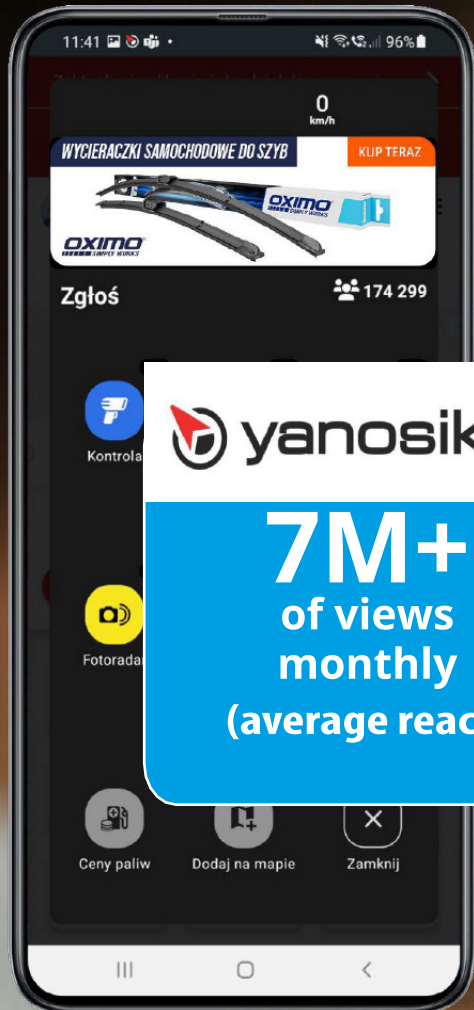

yanosik.pl

7M+
of views
monthly
(average reach)



Google

5M+
of views
monthly
(average reach)

ADVERTISING ON TV



WARNER BROS.



1.137
of spots
monthly

TV
spots

2.81 M+
of viewership
monthly

OXIMO
SIMPLY WORKS

MOTORSPORT EVENTS



Marketing support for our partners





BUSINESS DEVELOPMENT MANAGER

Sławomir Detmer

phone: +48 730 068 039

e-mail: slawomir.detmer@oximo.pl

BUSINESS DEVELOPMENT MANAGER

Oskar Bulczak

phone: +48 735 251 511

e-mail: oskar.bulczak@oximo.pl

WWW.OXIMO.PL